

ASSEMBLY AND INSTALLATION INSTRUCTIONS

W0168 / W0169 / W0189 / W0306

WARNING: TO AVOID RISK OF ELECTRICAL SHOCK, BE SURE TO SHUT OFF POWER WHILE INSTALLING OR SERVICING THIS FIXTURE.

NOTES: 1. Before installing, consult local electrical codes for wiring and grounding requirements.
2. READ AND SAVE THESE INSTRUCTIONS.

Hardware Package (included):



Mounting Plate (A)



Mounting Screw (B)



Green Grounding Screw (C)



Fixture mounting Screw (D)



Wire Connector (E)



Ball Nut (F)



Lock Nut (G)



Finial (I)

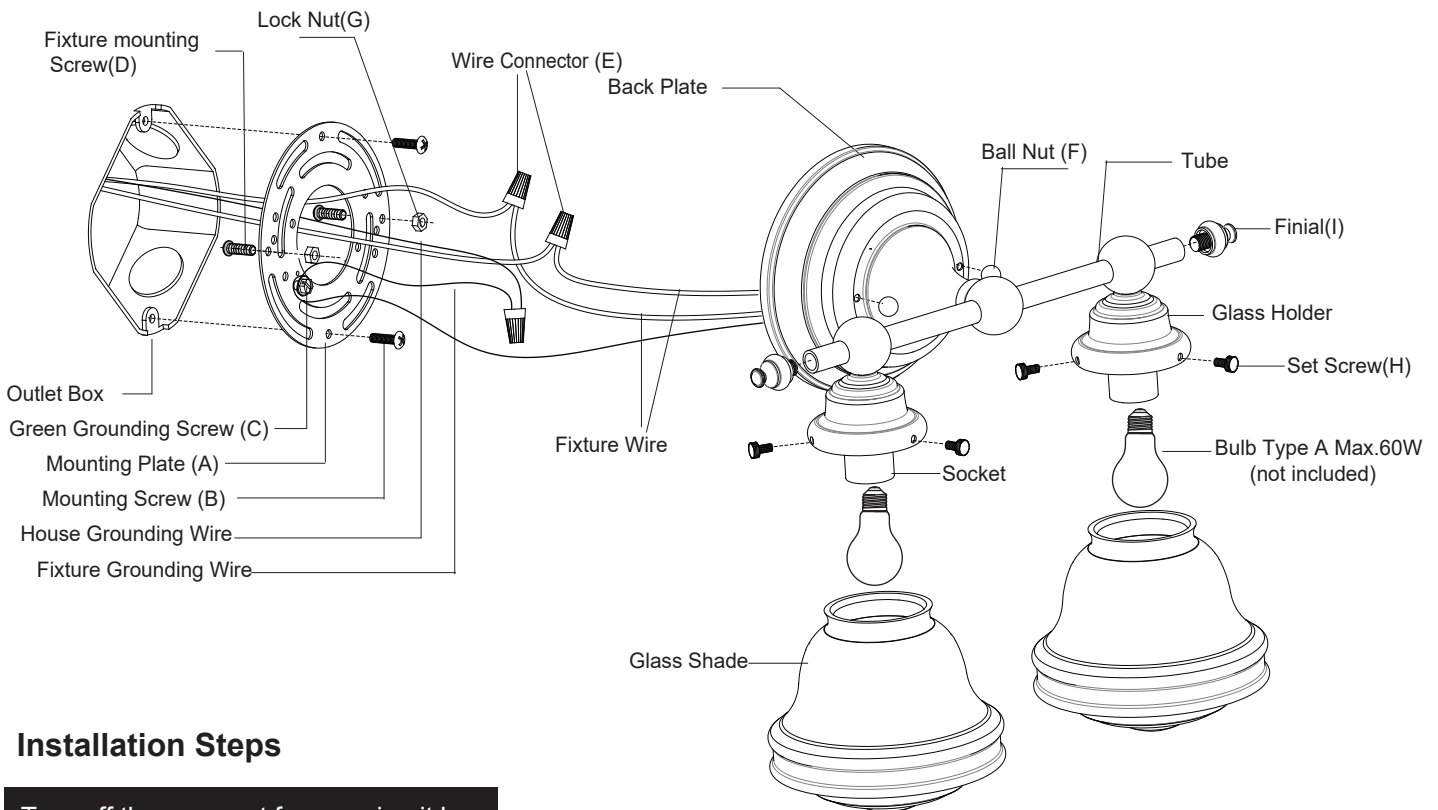

Installation Steps

Turn off the power at fuse or circuit box.

1. Unscrew two ball nuts, and then remove the mounting plate from the back plate.
2. Attach the mounting plate to the outlet box by using two mounting screws.
3. Pull out the source wires from the outlet box. Make wire connections using wire connectors as follow:
 - Connect the hot wire (usually black insulation) from the fixture to the black wire from the power source.
 - Connect the neutral wire (usually white insulation) from the fixture to the white wire from the power source.
 - Attach the fixture grounding wire (usually green insulation or bare wire) to the mounting plate with the green grounding screw, and then connect it to the house grounding wire with the wire connector.Carefully put the wires back into the outlet box.
4. Attach the back plate to the mounting plate by inserting two fixture mounting screws, and then secure it with two ball nuts.

 VAXCEL









181013

5. Install 2x60W Max. medium base bulbs (not included). Check relamping label at socket area or packaging for maximum allowed wattage.
6. Loosen three set screws and then attach the glass shade to the glass holder, finally secure it with three set screws. Repeat for another glass shade. (Don't over tighten.)
7. Screw two finials to two sides of tube tightly.

Turn on the power at fuse or circuit box.

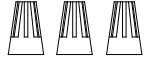
The following parts are available for re-order if damaged or missing.

Spare Parts List:

				→ Assembly Kit 5235MM (1 SET) for W0168/W0189 5236MM (1 SET) for W0169/W0306
Mounting Plate (A)	Mounting Screw (B)	Green Grounding Screw (C)	Fixture mounting Screw (D)	
				
Wire Connector (E)	Ball Nut (F)	Lock Nut (G)	Set Screw (H)	

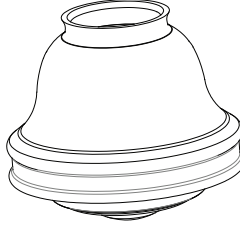

→ Glass Shade
9680MI(2PCS) for W0168/W0169
9681CS(2PCS) for W0189/W0306

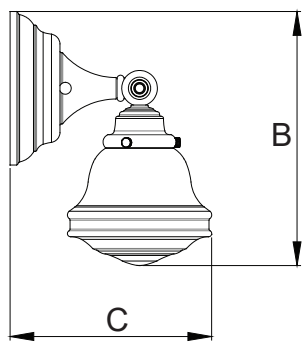
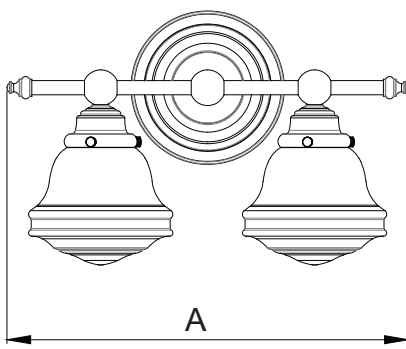

- A: 16"
- B: 10"
- C: 7"